

Paneles LED Slim

Slim LED Panels

GARANTÍA 3 AÑOS
3 YEARS WARRANTY



DESCRIPCIÓN - DESCRIPTION

Paneles LED Serie Slim disponibles en varios tamaños (60x60, 120x30, 120x60), potencias (40W y 60W) y temperaturas de color (4000K y 6000K). Además, están disponibles con UGR<19 y en versión regulable por Dali o 1-10V.

Backlight Series LED panels available in various sizes (60x60, 120x30, 120x60), powers (40W and 60W) and color temperatures (4000K and 6000K). In addition, the panels are available with UGR<19 and in a version dimmable by Dali or 1-10V.

ENLACES RELACIONADOS - RELATED LINKS

- [Declaración de conformidad CE / CE Declaration of Conformity \(ES\), \(EN\)](#)
- [ISO 9001](#)
- [ISO 14001](#)

GARANTÍA - WARRANTY

ALG le ofrece una garantía de **3 años** desde la fecha de compra.

ALG offers you a 3-year warranty from the date of purchase.



EN ISO 9001
20100193006513
EN ISO 14001
20104203009267

ALG dispone de un Sistema de Gestión de la Calidad según la norma ISO 9001 desde 1998 y desde el año 2021 estamos certificados con la norma 14001 para mejor conservación y protección del Medio Ambiente

ALG has a Quality Management System according to the ISO 9001 standard since 1998 and since 2021 we have been certified with the 14001 standard for better conservation and protection of the Environment.

INFORMACIÓN TÉCNICA · TECHNICAL INFORMATION: 60X60 NO DIMMABLE

DATOS COMERCIALES / COMMERCIAL DATA

CODE	67424	67425	67429
REFERENCE	PA60X60 40W 40K S	PA60X60 40W 60K S	PA60X60 40W40KUGR19

DATOS ELECTRICOS / ELECTRICAL DATA

INPUT VOLTAGE	220-240V	220-240V	220-240V
FREQUENCY	50Hz	50Hz	50Hz
POWER	40W	40W	40W
POWER FACTOR	0,90	0,90	0,90

DATOS FOTOMÉTRICOS / PHOTOMETRIC DATA

EFFICACY (LM/W)	100lm/W	100lm/W	97,5lm/W
LUMINOUS FLUX (LM)	4000lm	4000lm	3900lm
CCT (KELVIN)	4000K	6000K	4000K
CRI	80	80	80
BEAM ANGLE	120°	120°	120°

VIDA ÚTIL Y MEDIO AMBIENTE / LIFESPAN & ENVIRONMENTAL DATA

ENERGY CLASS	E	E	E
CONSUMPTION	40kWh/1000h	40kWh/1000h	40kWh/1000h
LIFESPAN	30000h	30000h	30000h
ON/OFF CICLES	15000	15000	15000
WORKING TEMP.	-20°C~+40°C	-20°C~+40°C	-20°C~+40°C

CARACTERÍSTICAS FÍSICAS / PHYSICAL CHARACTERISTICS

SIZE	595x595x10mm	595x595x10mm	595x595x10mm
CUT DIAMETER	575mm	575mm	575mm
COLOR	Blanco · White · Blanc	Blanco · White · Blanc	Blanco · White · Blanc
WEIGHT	2,300kg	2,300kg	2,300kg
IP PROTECTION	IP20	IP20	IP20

EMBALAJE / PACKAGING

CODE	67424	67425	67429
REFERENCE	PA60X60 40W 40K S	PA60X60 40W 60K S	PA60X60 40W40KUGR19
UNITS OUTER BOX	5	5	5

DIMENSIONES · SIZE

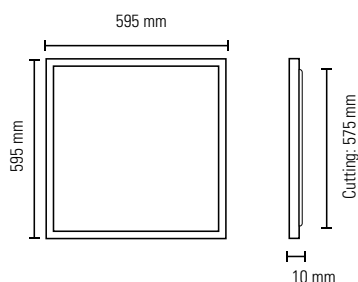

INFORMACIÓN TÉCNICA · TECHNICAL INFORMATION: 60X60 DIMMABLE 1-10V

DATOS COMERCIALES / COMMERCIAL DATA

CODE	67335	67336	67337
REFERENCE	PA60x60 40W 40K 0-10V	PA60x60 40W 60K 0-10V	PA60x60 40W 40K UGR19 0-10V

DATOS ELECTRICOS / ELECTRICAL DATA

INPUT VOLTAGE	220-240V	220-240V	220-240V
FREQUENCY	50Hz	50Hz	50Hz
POWER	40W	40W	40W
POWER FACTOR	0,90	0,90	0,90

DATOS FOTOMÉTRICOS / PHOTOMETRIC DATA

EFFICACY (LM/W)	100lm/W	100lm/W	97,5lm/W
LUMINOUS FLUX (LM)	4000lm	4000lm	3900lm
CCT (KELVIN)	4000K	6000K	4000K
CRI	80	80	80
BEAM ANGLE	120°	120°	120°

VIDA ÚTIL Y MEDIO AMBIENTE / LIFESPAN & ENVIRONMENTAL DATA

ENERGY CLASS	E	E	E
CONSUMPTION	40kWh/1000h	40kWh/1000h	40kWh/1000h
LIFESPAN	30000h	30000h	30000h
ON/OFF CICLES	15000	15000	15000
WORKING TEMP.	-20°C~+40°C	-20°C~+40°C	-20°C~+40°C

CARACTERÍSTICAS FÍSICAS / PHYSICAL CHARACTERISTICS

SIZE	595x595x10mm	595x595x10mm	595x595x10mm
CUT DIAMETER	575mm	575mm	575mm
COLOR	Blanco · White · Blanc	Blanco · White · Blanc	Blanco · White · Blanc
WEIGHT	2,300kg	2,300kg	2,300kg
IP PROTECTION	IP20	IP20	IP20

EMBALAJE / PACKAGING

CODE	67335	67336	67337
REFERENCE	PA60x60 40W 40K 0-10V	PA60x60 40W 60K 0-10V	PA60x60 40W 40K UGR19 0-10V
UNITS OUTER BOX	5	5	5

DIMENSIONES · SIZE

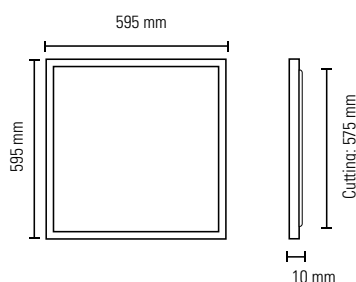

INFORMACIÓN TÉCNICA · TECHNICAL INFORMATION: 60X60 DIMMABLE DALI

DATOS COMERCIALES / COMMERCIAL DATA

CODE	67338	67339	67340
REFERENCE	PA60x60 40W 40K DALI	PA60x60 40W 60K DALI	PA60x60 40W 40K UGR19DALI

DATOS ELECTRICOS / ELECTRICAL DATA

INPUT VOLTAGE	220-240V	220-240V	220-240V
FREQUENCY	50Hz	50Hz	50Hz
POWER	40W	40W	40W
POWER FACTOR	0,90	0,90	0,90

DATOS FOTOMÉTRICOS / PHOTOMETRIC DATA

EFFICACY (LM/W)	100lm/W	100lm/W	97,5lm/W
LUMINOUS FLUX (LM)	4000lm	4000lm	3900lm
CCT (KELVIN)	4000K	6000K	4000K
CRI	80	80	80
BEAM ANGLE	120°	120°	120°

VIDA ÚTIL Y MEDIO AMBIENTE / LIFESPAN & ENVIRONMENTAL DATA

ENERGY CLASS	E	E	E
CONSUMPTION	40kWh/1000h	40kWh/1000h	40kWh/1000h
LIFESPAN	30000h	30000h	30000h
ON/OFF CICLES	15000	15000	15000
WORKING TEMP.	-20°C~+40°C	-20°C~+40°C	-20°C~+40°C

CARACTERÍSTICAS FÍSICAS / PHYSICAL CHARACTERISTICS

SIZE	595x595x10mm	595x595x10mm	595x595x10mm
CUT DIAMETER	575mm	575mm	575mm
COLOR	Blanco · White · Blanc	Blanco · White · Blanc	Blanco · White · Blanc
WEIGHT	2,300kg	2,300kg	2,300kg
IP PROTECTION	IP20	IP20	IP20

EMBALAJE / PACKAGING

CODE	67338	67339	67340
REFERENCE	PA60x60 40W 40K DALI	PA60x60 40W 60K DALI	PA60x60 40W 40K UGR19DALI
UNITS OUTER BOX	5	5	5

DIMENSIONES · SIZE

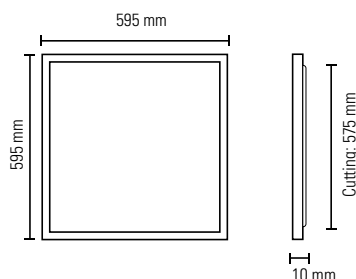

INFORMACIÓN TÉCNICA - TECHNICAL INFORMATION: **120X30 NO DIMMABLE****DATOS COMERCIALES / COMMERCIAL DATA**

CODE	67430	67432
REFERENCE	PA120X30 40W 40K	PA120X30 UGR19 40W 40K

DATOS ELECTRICOS / ELECTRICAL DATA

INPUT VOLTAGE	220-240V	220-240V
FREQUENCY	50Hz	50Hz
POWER	40W	40W
POWER FACTOR	0,90	0,90

DATOS FOTOMÉTRICOS / PHOTOMETRIC DATA

EFFICACY (LM/W)	100lm/W	97,5lm/W
LUMINOUS FLUX (LM)	4000lm	3900lm
CCT (KELVIN)	4000K	4000K
CRI	80	80
BEAM ANGLE	120°	120°

VIDA ÚTIL Y MEDIO AMBIENTE / LIFESPAN & ENVIRONMENTAL DATA

ENERGY CLASS	E	E
CONSUMPTION	40kWh/1000h	40kWh/1000h
LIFESPAN	30000h	30000h
ON/OFF CICLES	15000	15000
WORKING TEMP.	-20°C~+40°C	-20°C~+40°C

CARACTERÍSTICAS FÍSICAS / PHYSICAL CHARACTERISTICS

SIZE	1200x300x10mm	1200x300x10mm
CUT DIAMETER	1175x275mm	1175x275mm
COLOR	Blanco · White · Blanc	Blanco · White · Blanc
WEIGHT	2,300kg	2,300kg
IP PROTECTION	IP20	IP20

EMBALAJE / PACKAGING

CODE	67430	67432
REFERENCE	PA120X30 40W 40K	PA120X30 UGR19 40W 40K
UNITS OUTER BOX	5	5

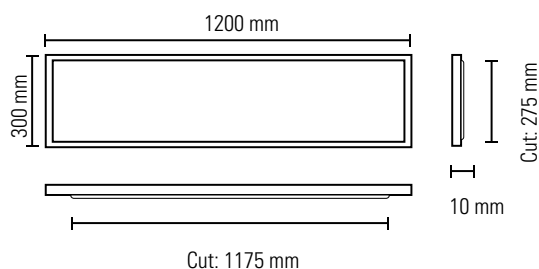
DIMENSIONES - SIZE

INFORMACIÓN TÉCNICA - TECHNICAL INFORMATION: 120X30 DIMMABLE 1-10V

DATOS COMERCIALES / COMMERCIAL DATA

CODE	67331	67332
REFERENCE	PA120X30 40W 40K 0-10V	PA120X30 UGR19 40W 40K 0-10V

DATOS ELECTRICOS / ELECTRICAL DATA

INPUT VOLTAGE	220-240V	220-240V
FREQUENCY	50Hz	50Hz
POWER	40W	40W
POWER FACTOR	0,90	0,90

DATOS FOTOMÉTRICOS / PHOTOMETRIC DATA

EFFICACY (LM/W)	100lm/W	97,5lm/W
LUMINOUS FLUX (LM)	4000lm	3900lm
CCT (KELVIN)	4000K	4000K
CRI	80	80
BEAM ANGLE	120°	120°

VIDA ÚTIL Y MEDIO AMBIENTE / LIFESPAN & ENVIRONMENTAL DATA

ENERGY CLASS	E	E
CONSUMPTION	40kWh/1000h	40kWh/1000h
LIFESPAN	30000h	30000h
ON/OFF CICLES	15000	15000
WORKING TEMP.	-20°C~+40°C	-20°C~+40°C

CARACTERÍSTICAS FÍSICAS / PHYSICAL CHARACTERISTICS

SIZE	1200x300x10mm	1200x300x10mm
CUT DIAMETER	1175x275mm	1175x275mm
COLOR	Blanco · White · Blanc	Blanco · White · Blanc
WEIGHT	2,300kg	2,300kg
IP PROTECTION	IP20	IP20

EMBALAJE / PACKAGING

CODE	67331	67332
REFERENCE	PA120X30 40W 40K 0-10V	PA120X30 UGR19 40W 40K 0-10V
UNITS OUTER BOX	5	5

DIMENSIONES - SIZE

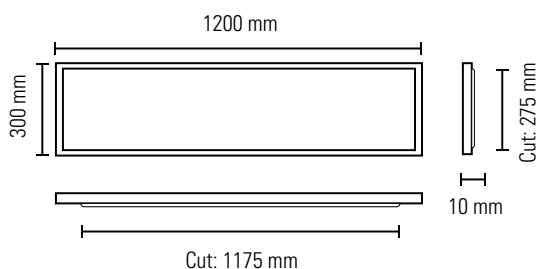

INFORMACIÓN TÉCNICA - TECHNICAL INFORMATION: 120X30 DIMMABLE DALI

DATOS COMERCIALES / COMMERCIAL DATA

CODE	67333	67334
REFERENCE	PA120X30 40W 40K DALI	PA120X30 UGR19 40W 40K DALI

DATOS ELECTRICOS / ELECTRICAL DATA

INPUT VOLTAGE	220-240V	220-240V
FREQUENCY	50Hz	50Hz
POWER	40W	40W
POWER FACTOR	0,90	0,90

DATOS FOTOMÉTRICOS / PHOTOMETRIC DATA

EFFICACY (LM/W)	100lm/W	97,5lm/W
LUMINOUS FLUX (LM)	4000lm	3900lm
CCT (KELVIN)	4000K	4000K
CRI	80	80
BEAM ANGLE	120°	120°

VIDA ÚTIL Y MEDIO AMBIENTE / LIFESPAN & ENVIRONMENTAL DATA

ENERGY CLASS	E	E
CONSUMPTION	40kWh/1000h	40kWh/1000h
LIFESPAN	30000h	30000h
ON/OFF CICLES	15000	15000
WORKING TEMP.	-20°C~+40°C	-20°C~+40°C

CARACTERÍSTICAS FÍSICAS / PHYSICAL CHARACTERISTICS

SIZE	1200x300x10mm	1200x300x10mm
CUT DIAMETER	1175x275mm	1175x275mm
COLOR	Blanco · White · Blanc	Blanco · White · Blanc
WEIGHT	2,300kg	2,300kg
IP PROTECTION	IP20	IP20

EMBALAJE / PACKAGING

CODE	67333	67334
REFERENCE	PA120X30 40W 40K DALI	PA120X30 UGR19 40W 40K DALI
UNITS OUTER BOX	5	5

DIMENSIONES - SIZE

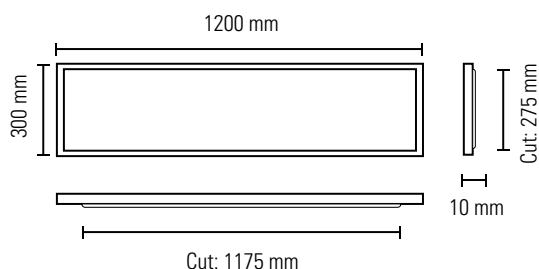

INFORMACIÓN TÉCNICA - TECHNICAL INFORMATION: 120X60 NO DIMMABLE

DATOS COMERCIALES / COMMERCIAL DATA

CODE	67431	67433
REFERENCE	PA120X60 60W 40K	PA120X60 UGR19 60W 40K

DATOS ELECTRICOS / ELECTRICAL DATA

INPUT VOLTAGE	220-240V	220-240V
FREQUENCY	50Hz	50Hz
POWER	60W	60W
POWER FACTOR	0,90	0,90

DATOS FOTOMÉTRICOS / PHOTOMETRIC DATA

EFFICACY (LM/W)	103lm/W	100lm/W
LUMINOUS FLUX (LM)	6200lm	6000lm
CCT (KELVIN)	4000K	4000K
CRI	80	80
BEAM ANGLE	120°	120°

VIDA ÚTIL Y MEDIO AMBIENTE / LIFESPAN & ENVIRONMENTAL DATA

ENERGY CLASS	E	E
CONSUMPTION	40kWh/1000h	40kWh/1000h
LIFESPAN	30000h	30000h
ON/OFF CICLES	15000	15000
WORKING TEMP.	-20°C~+40°C	-20°C~+40°C

CARACTERÍSTICAS FÍSICAS / PHYSICAL CHARACTERISTICS

SIZE	1200x600x10mm	1200x600x10mm
CUT DIAMETER	1175x575mm	1175x575mm
COLOR	Blanco · White · Blanc	Blanco · White · Blanc
WEIGHT	5,700kg	5,700kg
IP PROTECTION	IP20	IP20

EMBALAJE / PACKAGING

CODE	67431	67433
REFERENCE	PA120X60 60W 40K	PA120X60 UGR19 60W 40K
UNITS OUTER BOX	5	5

DIMENSIONES - SIZE

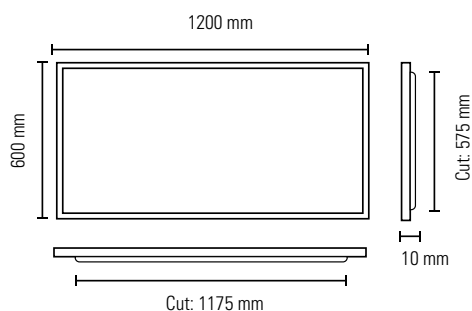

ACCESORIOS - ACCESSORIES: 60X60

KIT DE SUPERFICIE / SURFACE KIT

CODE	67410
REFERENCE	SUPERFICIE PAN 60X60
DESCRIPTION	Elementos de fijación de superficie para paneles · Surface fixing elements for panels
SIZE	600x600x50mm
THICKNESS	1,13mm
WEIGHT	553 g
MATERIAL	Aluminio
COLOR	Blanco



El kit se compone de 5 partes:

- Las 4 partes metálicas que forman el marco.
- Tacos y tornillos para su fijación allí donde vaya ubicado y los tornillos para sujetar el marco una vez montado.

The kit has 5 parts:

- The 4 metal parts that make up the frame.
- Plugs and screws for fixing where it is located and the screws to hold the frame once assembled.

KIT DE SUSPENSIÓN / SUSPENSION SYSTEM KIT

CODE	67411
REFERENCE	SUSPENSIÓN PANEL 4C
DESCRIPTION	Sistema de suspensión con 4 cables de 1,5m · Suspension system with 4 cables of 1,5m
LENGTH	1m
DIAMETER	1,2mm
WEIGHT	6 g
MATERIAL	Acero inox.
COLOR	Gris acero mate



El kit se compone de los siguientes elementos:

- 4 cables de acero trenzado.
- 4 tornillos y tacos para su sujeción allí donde vaya ubicado.
- 4 embellecedores para los tornillos de sujeción
- 4 regletas metálicas para sujetar el cable (impide que se escurra).

The kit consists of the following elements:

- 4 braided steel cables.
- 4 screws and plugs for its fastening wherever it is located
- 4 trims for the fastening screws.
- 4 metal strips to hold the cable (prevents it from slipping).

ACCESORIOS - ACCESSORIES: 60X60

MARCO DE EMPOTRAR / EMBEDDED FRAME 60X60

CODE	67395
REFERENCE	MARCO EMPOTRAR PANEL 60X60
DESCRIPTION	Marco para empotrar el panel en el techo. · Frame to embed the panel in the ceiling.
SIZE	625x625x25mm
THICKNESS	1,4mm
MATERIAL	Aluminio
COLOR	Blanco



El kit se compone de los siguientes elementos:

- Marco de aluminio blanco para empotrar el panel en el techo.
- 4 garras flexibles de acero inoxidable.
- 4 tornillos.

The kit consists of the following elements:

- White aluminum frame to embed the panel in the ceiling.
- 4 flexible stainless steel claws.
- 4 screws.

ACCESORIOS - ACCESSORIES: 60X60 / 120X30

GARRAS DE EMPOTRAR / EMBEDDED FIXING ELEMENTS 60X60 / 120X30

CODE	67426
REFERENCE	FIJACIÓN PAN EMPOTRAB (60X60 / 120X30)
DESCRIPTION	Elementos de fijación para empotrar el panel en el techo · Fixing elements to embed the panel in the ceiling
BASE LENGTH	39,99mm
BASE WIDTH	16,97mm
CLAW LENGTH	49,76mm
TOTAL HEIGHT	27,37mm
THICKNESS	1mm
WEIGHT	19 g
MATERIAL	Acero inox.
COLOR	Gris acero



El kit se compone de los siguientes elementos:

- 4 garras flexibles de acero inoxidable.
- Tornillos para anclar las garras al panel.

The kit consists of the following elements:

- 4 flexible stainless steel claws.
- Screws to anchor the claws to the panel.

ACCESORIOS - ACCESSORIES: 120X30 /120X60

KIT DE SUPERFICIE / SURFACE KIT 120X30

CODE	67436
REFERENCE	SUPERFICIE PAN 120X30
DESCRIPTION	Elementos de fijación de superficie para paneles · Surface fixing elements for panels
SIZE	300x1200x50mm
THICKNESS	1,13mm
MATERIAL	Aluminio
COLOR	Blanco



El kit se compone de 5 partes:

- Las 4 partes metálicas que forman el marco.
- Tacos y tornillos para su fijación allí donde vaya ubicado y los tornillos para sujetar el marco una vez montado.

The kit has 5 parts:

- The 4 metal parts that make up the frame.
- Plugs and screws for fixing where it is located and the screws to hold the frame once assembled.



KIT DE SUPERFICIE / SURFACE KIT 120X60

CODE	67435
REFERENCE	SUPERFICIE PAN 120X60
DESCRIPTION	Elementos de fijación de superficie para paneles · Surface fixing elements for panels
SIZE	600x1200x50mm
THICKNESS	1,13mm
MATERIAL	Aluminio
COLOR	Blanco



El kit se compone de 5 partes:

- Las 4 partes metálicas que forman el marco.
- Tacos y tornillos para su fijación allí donde vaya ubicado y los tornillos para sujetar el marco una vez montado.

The kit has 5 parts:

- The 4 metal parts that make up the frame.
- Plugs and screws for fixing where it is located and the screws to hold the frame once assembled.



ACCESORIOS · ACCESSORIES: 120X30 / 120X60

KIT DE SUSPENSIÓN / SUSPENSION SYSTEM KIT

CODE	67437
REFERENCE	SUSPENSIÓN PANEL 6C (120X30 / 120X60)
DESCRIPTION	Sistema de suspensión con 6 cables de 1,5m · Suspension system with 6 cables of 1.5m
BASE LENGTH	39,99mm
BASE WIDTH	16,97mm
CLAW LENGTH	49,76mm
TOTAL HEIGHT	27,37mm
THICKNESS	1mm
WEIGHT	19 g
MATERIAL	Acero inox.
COLOR	Gris acero



El kit se compone de los siguientes elementos:

- 6 cables de 1.5m.
- Tornillos para anclar las garras al panel.

The kit consists of the following elements:

- 6 cables de 1.5m.
- Screws to anchor the claws to the panel.

GARRAS DE EMPOTRAR / EMBEDDED FIXING ELEMENTS 120X60

CODE	67434
REFERENCE	FIJ. PAN. EMP. 60X120
DESCRIPTION	Elementos de fijación para empotrar el panel en el techo · Fixing elements to embed the panel in the ceiling
BASE LENGTH	39,99mm
BASE WIDTH	16,97mm
CLAW LENGTH	49,76mm
TOTAL HEIGHT	27,37mm
THICKNESS	1mm
WEIGHT	19 g
MATERIAL	Acero inox.
COLOR	Gris acero



El kit se compone de los siguientes elementos:

- 6 garras flexibles de acero inoxidable.
- Tornillos para anclar las garras al panel.

The kit consists of the following elements:

- 6 flexible stainless steel claws.
- Screws to anchor the claws to the panel.