

## Paneles Backlight

### Backlight Panels

**GARANTÍA 3 AÑOS**  
**3 YEARS WARRANTY**



#### DESCRIPCIÓN · DESCRIPTION

Paneles LED Serie Backlight disponibles en varios tamaños (60x60, 120x30, 120x60), potencias (40W y 60W) y temperaturas de color (4000K y 6000K). Además, los paneles de 60x60 están disponibles con UGR<19 y en versión regulable por Dali o 1-10V. **Libres de flicker.** La serie Backlight destaca gracias a su construcción por capas y la distribución cuidadosa de lentes ópticas sobre cada uno de los chips de LED en su PCB de aluminio, lo que evita el deterioro del difusor con el paso del tiempo. De esta forma, los paneles Backlight mantienen la distribución de la luz y el tono de blanco intactos durante mucho más tiempo.

*Backlight Series LED panels available in various sizes (60x60, 120x30, 120x60), powers (40W and 60W) and color temperatures (4000K and 6000K). In addition, the 60x60 panels are available with UGR<19 and in a version dimmable by Dali or 1-10V. **Flicker free.** The Backlight series stands out thanks to its layered construction and the careful distribution of optical lenses over each of the LED chips on its aluminum PCB, which prevents deterioration of the diffuser over time. In this way, Backlight panels keep the distribution of light and the white tone intact for much longer.*

#### ENLACES RELACIONADOS · RELATED LINKS

- [Declaración de conformidad CE / CE Declaration of Conformity \(ES\), \(EN\)](#)
- [ISO 9001](#)
- [ISO 14001](#)

#### GARANTÍA · WARRANTY

ALG le ofrece una garantía de **3 años** desde la fecha de compra.

*ALG offers you a **3-year warranty** from the date of purchase.*



ALG dispone de un Sistema de Gestión de la Calidad según la norma ISO 9001 desde 1998 y desde el año 2021 estamos certificados con la norma 14001 para mejor conservación y protección del Medio Ambiente

*ALG has a Quality Management System according to the ISO 9001 standard since 1998 and since 2021 we have been certified with the 14001 standard for better conservation and protection of the Environment.*

## INFORMACIÓN TÉCNICA · TECHNICAL INFORMATION: 60X60 NO DIMMABLE

### DATOS COMERCIALES / COMMERCIAL DATA

CODE	67046	67048	67365
REFERENCE	PANEL BACKLIGHT 40W 60X60 40K	PANEL BACKLIGHT 40W 60X60 60K	PANEL BACKLIGHT 40W 60X60 UGR<19 40K

### DATOS ELECTRICOS / ELECTRICAL DATA

INPUT VOLTAGE	220-240V	220-240V	220-240V
FREQUENCY	50Hz	50Hz	50Hz
POWER	40W	40W	40W
POWER FACTOR	0,90	0,90	0,90

### DATOS FOTOMÉTRICOS / PHOTOMETRIC DATA

EFFICACY (LM/W)	105lm/W	105lm/W	105lm/W
LUMINOUS FLUX (LM)	4200lm	4200lm	4200lm
CCT (KELVIN)	4000K	6000K	4000K
CRI	80	80	80
BEAM ANGLE	120°	120°	120°

### VIDA ÚTIL Y MEDIO AMBIENTE / LIFESPAN & ENVIRONMENTAL DATA

ENERGY CLASS	E	E	E
CONSUMPTION	40kWh/1000h	40kWh/1000h	40kWh/1000h
LIFESPAN	30000h	30000h	30000h
ON/OFF CICLES	20000	20000	20000
WORKING TEMP.	-20°C~+40°C	-20°C~+40°C	-20°C~+40°C

### CARACTERÍSTICAS FÍSICAS / PHYSICAL CHARACTERISTICS

SIZE	595x595x34mm	595x595x34mm	595x595x34mm
CUT DIAMETER	575mm	575mm	575mm
COLOR	Blanco · White · Blanc	Blanco · White · Blanc	Blanco · White · Blanc
WEIGHT	1,680kg	1,680kg	1,680kg
IP PROTECTION	IP20	IP20	IP20

### EMBALAJE / PACKAGING

CODE	67046	67048	67365
REFERENCE	PANEL BACKLIGHT 40W 60X60 40K	PANEL BACKLIGHT 40W 60X60 60K	PANEL BACKLIGHT 40W 60X60 UGR<19 40K
UNITS OUTER BOX	5	5	5

## DIMENSIONES · SIZE

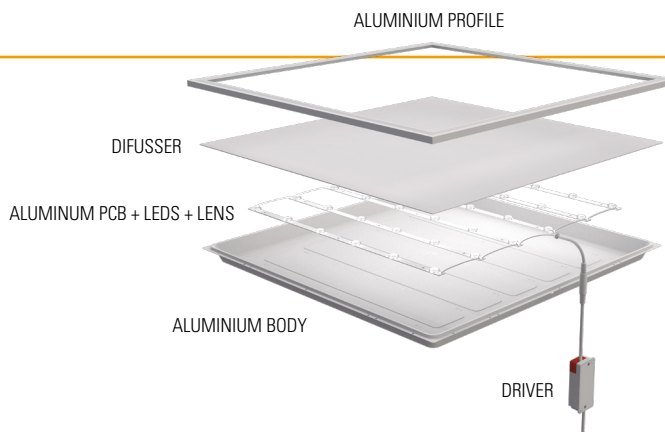
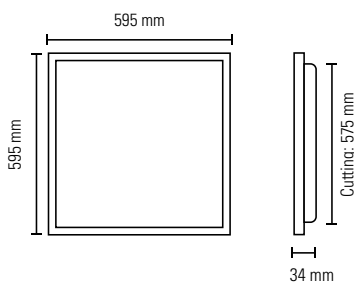

ANTONIO LOPEZ GARRIDO,S.A.

Avda. Comarques del País Valencià, 60 46930 Quart de Poblet (Valencia) España  
(+34) 96 192 06 30 [pedidos@algsa.es](mailto:pedidos@algsa.es) [www.algsa.es](http://www.algsa.es)

01 October 2024

## INFORMACIÓN TÉCNICA · TECHNICAL INFORMATION: 60X60 DIMMABLE 1-10V

### DATOS COMERCIALES / COMMERCIAL DATA

CODE	67473	67474	67475
REFERENCE	PA60x60 BACKLIGHT 40W 40K 0-10V	PA60x60 BACKLIGHT 40W 60K 0-10V	PA60x60 BACKLIGHT 40W 40K UGR19 0-10V

### DATOS ELECTRICOS / ELECTRICAL DATA

INPUT VOLTAGE	220-240V	220-240V	220-240V
FREQUENCY	50Hz	50Hz	50Hz
POWER	40W	40W	40W
POWER FACTOR	0,90	0,90	0,90

### DATOS FOTOMÉTRICOS / PHOTOMETRIC DATA

EFFICACY (LM/W)	105lm/W	105lm/W	105lm/W
LUMINOUS FLUX (LM)	4200lm	4200lm	4200lm
CCT (KELVIN)	4000K	6000K	4000K
CRI	80	80	80
BEAM ANGLE	120°	120°	120°

### VIDA ÚTIL Y MEDIO AMBIENTE / LIFESPAN & ENVIRONMENTAL DATA

ENERGY CLASS	E	E	E
CONSUMPTION	40kWh/1000h	40kWh/1000h	40kWh/1000h
LIFESPAN	30000h	30000h	30000h
ON/OFF CICLES	20000	20000	20000
WORKING TEMP.	-20°C~+40°C	-20°C~+40°C	-20°C~+40°C

### CARACTERÍSTICAS FÍSICAS / PHYSICAL CHARACTERISTICS

SIZE	595x595x34mm	595x595x34mm	595x595x34mm
CUT DIAMETER	575mm	575mm	575mm
COLOR	Blanco · White · Blanc	Blanco · White · Blanc	Blanco · White · Blanc
WEIGHT	1,680kg	1,680kg	1,680kg
IP PROTECTION	IP20	IP20	IP20

### EMBALAJE / PACKAGING

CODE	67473	67474	67475
REFERENCE	PA60x60 BACKLIGHT 40W 40K 0-10V	PA60x60 BACKLIGHT 40W 60K 0-10V	PA60x60 BACKLIGHT 40W 40K UGR19 0-10V
UNITS OUTER BOX	5	5	5

## DIMENSIONES · SIZE

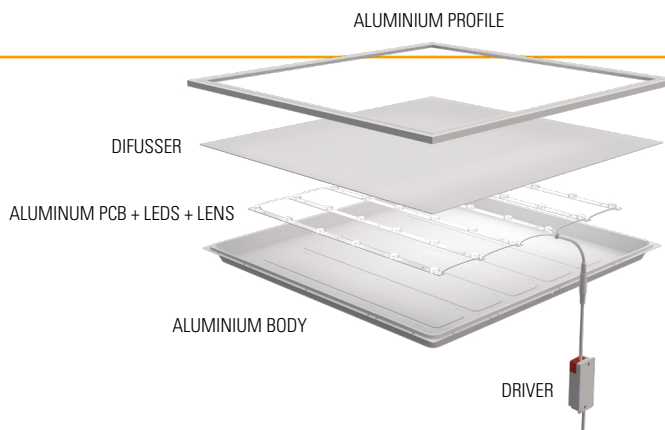
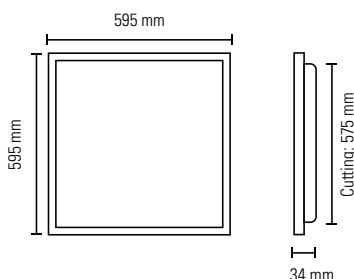

ANTONIO LOPEZ GARRIDO,S.A.

Avda. Comarques del País Valencià, 60 46930 Quart de Poblet (Valencia) España  
(+34) 96 192 06 30 [pedidos@algsa.es](mailto:pedidos@algsa.es) [www.algsa.es](http://www.algsa.es)

01 October 2024

## INFORMACIÓN TÉCNICA · TECHNICAL INFORMATION: 60X60 DIMMABLE DALI

### DATOS COMERCIALES / COMMERCIAL DATA

CODE	67476	67477	67478
REFERENCE	PA60x60 BACKLIGHT 40W 40K DALI	PA60x60 BACKLIGHT 40W 60K DALI	PA60x60 BACKLIGHT 40W 40K UGR19 DALI

### DATOS ELECTRICOS / ELECTRICAL DATA

INPUT VOLTAGE	220-240V	220-240V	220-240V
FREQUENCY	50Hz	50Hz	50Hz
POWER	40W	40W	40W
POWER FACTOR	0,90	0,90	0,90

### DATOS FOTOMÉTRICOS / PHOTOMETRIC DATA

EFFICACY (LM/W)	105lm/W	105lm/W	105lm/W
LUMINOUS FLUX (LM)	4200lm	4200lm	4200lm
CCT (KELVIN)	4000K	6000K	4000K
CRI	80	80	80
BEAM ANGLE	120°	120°	120°

### VIDA ÚTIL Y MEDIO AMBIENTE / LIFESPAN & ENVIRONMENTAL DATA

ENERGY CLASS	E	E	E
CONSUMPTION	40kWh/1000h	40kWh/1000h	40kWh/1000h
LIFESPAN	30000h	30000h	30000h
ON/OFF CICLES	20000	20000	20000
WORKING TEMP.	-20°C~+40°C	-20°C~+40°C	-20°C~+40°C

### CARACTERÍSTICAS FÍSICAS / PHYSICAL CHARACTERISTICS

SIZE	595x595x34mm	595x595x34mm	595x595x34mm
CUT DIAMETER	575mm	575mm	575mm
COLOR	Blanco · White · Blanc	Blanco · White · Blanc	Blanco · White · Blanc
WEIGHT	1,680kg	1,680kg	1,680kg
IP PROTECTION	IP20	IP20	IP20

### EMBALAJE / PACKAGING

CODE	67476	67477	67478
REFERENCE	PA60x60 BACKLIGHT 40W 40K DALI	PA60x60 BACKLIGHT 40W 60K DALI	PA60x60 BACKLIGHT 40W 40K UGR19 DALI
UNITS OUTER BOX	5	5	5

## DIMENSIONES · SIZE

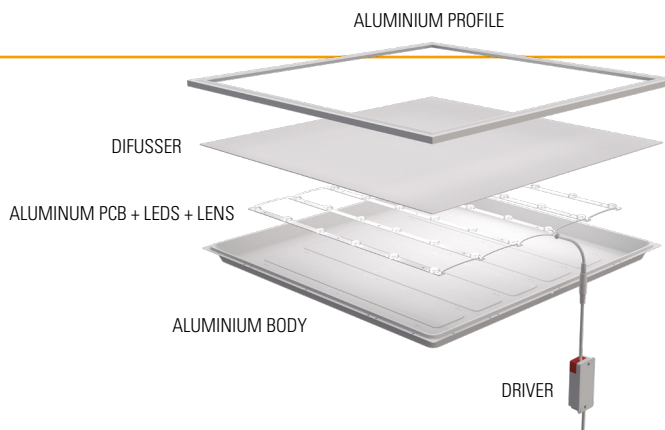
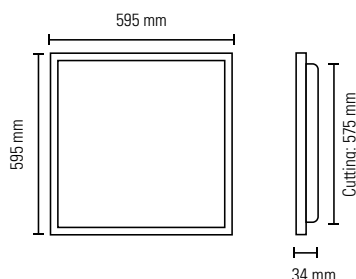

ANTONIO LOPEZ GARRIDO,S.A.

Avda. Comarques del País Valencià, 60 46930 Quart de Poblet (Valencia) España  
(+34) 96 192 06 30 [pedidos@algsa.es](mailto:pedidos@algsa.es) [www.algsa.es](http://www.algsa.es)

01 October 2024

## INFORMACIÓN TÉCNICA · TECHNICAL INFORMATION: 120X30 NO DIMMABLE

### DATOS COMERCIALES / COMMERCIAL DATA

CODE	67355	67512	67843
REFERENCE	PANEL BACKLIGHT 40W 120X30 40K	PANEL BACKLIGHT 40W 120X30 60K	PANEL BACKLIGHT 40W 120X30 UGR<19 40K

### DATOS ELECTRICOS / ELECTRICAL DATA

INPUT VOLTAGE	220-240V	220-240V	220-240V
FREQUENCY	50Hz	50Hz	50Hz
POWER	40W	40W	40W
POWER FACTOR	0,90	0,90	0,90

### DATOS FOTOMÉTRICOS / PHOTOMETRIC DATA

EFFICACY (LM/W)	110lm/W	110lm/W	110lm/W
LUMINOUS FLUX (LM)	4400lm	4400lm	4400lm
CCT (KELVIN)	4000K	6000K	4000K
CRI	80	80	80
BEAM ANGLE	120°	120°	120°

### VIDA ÚTIL Y MEDIO AMBIENTE / LIFESPAN & ENVIRONMENTAL DATA

ENERGY CLASS	E	E	E
CONSUMPTION	40kWh/1000h	40kWh/1000h	40kWh/1000h
LIFESPAN	30000h	30000h	30000h
ON/OFF CICLES	20000	20000	20000
WORKING TEMP.	-20°C~+40°C	-20°C~+40°C	-20°C~+40°C

### CARACTERÍSTICAS FÍSICAS / PHYSICAL CHARACTERISTICS

SIZE	1195x295x34mm	1195x295x34mm	1195x295x34mm
CUT DIAMETER	1175x275mm	1175x275mm	1175x275mm
COLOR	Blanco · White · Blanc	Blanco · White · Blanc	Blanco · White · Blanc
WEIGHT	1,680kg	1,680kg	1,680kg
IP PROTECTION	IP20	IP20	IP20

### EMBALAJE / PACKAGING

CODE	67355	67512	67843
REFERENCE	PANEL BACKLIGHT 40W 120X30 40K	PANEL BACKLIGHT 40W 120X30 60K	PANEL BACKLIGHT 40W 120X30 UGR<19 40K
UNITS OUTER BOX	8	8	8

## DIMENSIONES · SIZE

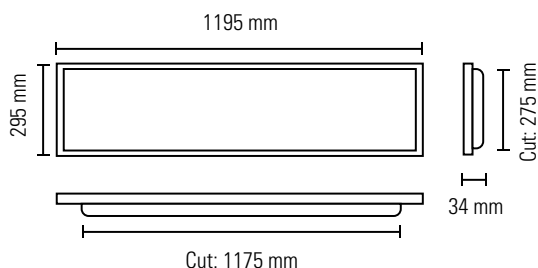

## INFORMACIÓN TÉCNICA · TECHNICAL INFORMATION: 120X60 NO DIMMABLE

### DATOS COMERCIALES / COMMERCIAL DATA

CODE	67364	67521	67844
REFERENCE	PANEL BACKLIGHT 60W 120X60 40K	PANEL BACKLIGHT 60W 120X60 60K	PANEL BACKLIGHT 60W 120X60 UGR<19 40K

### DATOS ELECTRICOS / ELECTRICAL DATA

INPUT VOLTAGE	220-240V	220-240V	220-240V
FREQUENCY	50Hz	50Hz	50Hz
POWER	60W	60W	60W
POWER FACTOR	0,90	0,90	0,90

### DATOS FOTOMÉTRICOS / PHOTOMETRIC DATA

EFFICACY (LM/W)	108lm/W	108lm/W	108lm/W
LUMINOUS FLUX (LM)	6500lm	6500lm	6500lm
CCT (KELVIN)	4000K	6000K	4000K
CRI	80	80	80
BEAM ANGLE	120°	120°	120°

### VIDA ÚTIL Y MEDIO AMBIENTE / LIFESPAN & ENVIRONMENTAL DATA

ENERGY CLASS	E	E	E
CONSUMPTION	60kWh/1000h	60kWh/1000h	60kWh/1000h
LIFESPAN	30000h	30000h	30000h
ON/OFF CICLES	20000	20000	20000
WORKING TEMP.	-20°C~+40°C	-20°C~+40°C	-20°C~+40°C

### CARACTERÍSTICAS FÍSICAS / PHYSICAL CHARACTERISTICS

SIZE	1195x595x34mm	1195x595x34mm	1195x595x34mm
CUT DIAMETER	1175x575mm	1175x575mm	1175x575mm
COLOR	Blanco · White · Blanc	Blanco · White · Blanc	Blanco · White · Blanc
WEIGHT	1,680kg	1,680kg	1,680kg
IP PROTECTION	IP20	IP20	IP20

### EMBALAJE / PACKAGING

CODE	67364	67521	67521
REFERENCE	PANEL BACKLIGHT 60W 120X60 40K	PANEL BACKLIGHT 60W 120X60 60K	PANEL BACKLIGHT 60W 120X60 UGR<19 40K
UNITS OUTER BOX	8	8	8

## DIMENSIONES · SIZE

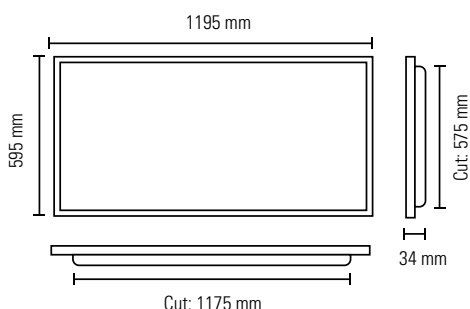

## ACCESORIOS - ACCESSORIES

CODE	REFERENCE	DESCRIPTION	FOR PANEL SIZES
67061	ACC. EMPOTRAR BACKLIGHT 60X60/120X30	4 garras de sujeción y 8 tornillos para instalación empotrable 4 clamping claws and 8 screws for flush mounting.	60X60 / 120X30
67049	ACC. SUPERFICIE BACKLIGHT 60X60	4 piezas de aluminio pintado en blanco y 8 tornillos para su montaje. 4 pieces of aluminium painted white and 8 screws for mounting.	60X60
67373	ACC. SUPERFICIE BACKLIGHT 120X30	4 piezas de aluminio pintado en blanco y 8 tornillos para su montaje. 4 pieces of aluminium painted white and 8 screws for mounting.	120X30
67374	ACC. EMPOTRAR BACKLIGHT 120X60	6 garras de sujeción y 12 tornillos para instalación empotrable 6 clamping claws and 12 screws for flush mounting.	120X60
67375	ACC. SUPERFICIE BACKLIGHT 120X60	4 piezas de aluminio pintado en blanco y 8 tornillos para su montaje. 4 pieces of aluminium painted white and 8 screws for mounting.	120X60